

DATE	PROJECT	FIRM	TYPE
------	---------	------	------

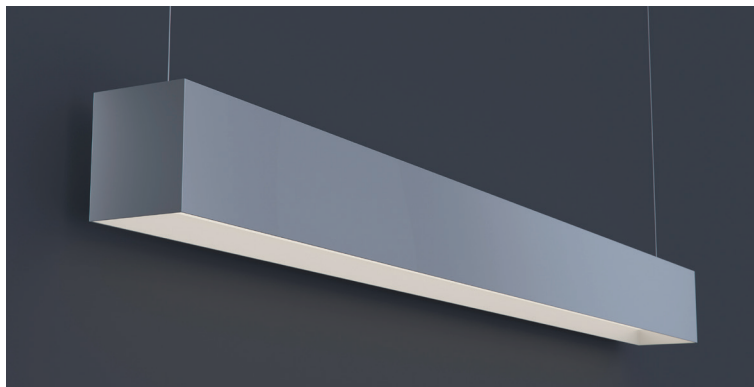

Linear, architectural luminaire with regressed lens. For indoor applications where an LED luminaire providing continuous light is required. Suitable for suspended, surface or wall mount installation. For custom mounting consult factory.

FEATURES

- Available In Custom Lengths & Long Runs To 1/16" Accuracy
- Corners & Patterns Available (See Page 2)
- Damp Location Rated
- CRI 90+ Standard
- 5 Year, 50,000 Hour Fixture Warranty
- 2700K, 3000K, 3500K, 4000K & 5000K Color Temperatures Available
- Enlighted/Wattstopper Sensors Available

APPLICATIONS Offices, Lobbies, Retail Stores, Classrooms, Reception Areas & Corridors

CONSTRUCTION Extruded Aluminum Housing And Steel End Caps With 1" Regressed Lens. Formed Steel Gear Tray

OPTICS Extruded High Transmission Satin Acrylic Lens With No LED Imaging

WARRANTY 5 Year Limited Warranty (Covers Standard Components)

FINISH Standard Powder-Coated White. Custom RAL Colors Available

FIXTURE RATINGS & CERTIFICATIONS Union Made Made In The USA
ETL Listed Damp Location Rated



ELECTRICAL Integral Driver With 0-10V 10% Dimming Standard. Several Driver Options Available. See Below For Lutron Dimming Information

2-Wire Forward Phase; Hi-Lume 1% Dimming, Only Available For 120V	LTEA
3-Wire EcoSystem; Hi-lume 1% Dimming	L3DA
Digital EcoSystem; Hi-lume 1% Dimming, 'Soft-on Fade-to-black' (Required for Daylighting)	LDE1
5 Series EcoSystem; 5% Dimming	LDE5

EXTRUSION DIMENSIONS

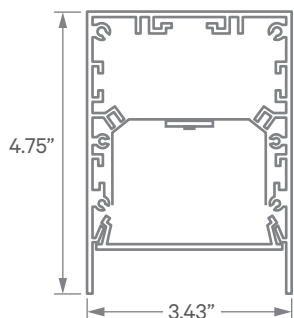

LED SYSTEM INFORMATION

	Nominal System Watts	Nominal Delivered Lumens	Nominal Efficacy
Standard (LTG1)	7.25 W/ft	625 Lm/ft	86 Lm/W
Low (LTG2)	5 W/ft	430 Lm/ft	86 Lm/W
High (LTG3)	8.75 W/ft	715 Lm/ft	81 Lm/W

Based on a 3500K luminaire using one driver. Please consult factory for custom lumen outputs & wattage.

ORDERING

1	2	3	4	5	6	7	8	9	10	11
---	---	---	---	---	---	---	---	---	----	----

<p>1 - FIXTURE ID</p> <p>KLS4 LED RG</p>	<p>2 - LENGTH</p> <p>2 - 2 ft 4 - 4 ft 8 - 8 ft x'-x" - Custom (specify length)</p> <p>**Patterns available, consult factory</p>	<p>3 - COLOR TEMP</p> <p>27 - 2700K/90 CRI 30 - 3000K/90 CRI 35 - 3500K/90 CRI 40 - 4000K/90 CRI 50 - 5000K/90 CRI TW* - Tunable White RGBW* - RGB + 3000K</p> <p>*Must use DMX Driver (Remote)</p>	<p>4 - LED SYSTEM</p> <p>LTG1 - Standard LTG2 - Low LTG3 - High C - Custom Output (ie-C550Lm/ft)</p>	<p>5 - VOLTAGE</p> <p>UNV - Universal (120/277V)</p>	<p>6 - DRIVER</p> <p>DB - Standard 10% Dimming (0-10V) DB1% - 1% Dimming (0-10V) DB.01% - .01% Dimming (0-10V) LTEA* - Lutron 2-wire 1% Dimming L3DA* - Lutron 3-wire 1% Dimming LDE1* - Lutron Digital EcoSystem LDE5* - 5 Series EcoSystem; 5% Dimming</p> <p>*Refer to 'Electrical' Information Above DMX - For Color Tuning and RGBW</p>
<p>7 - FINISH</p> <p>W - White (Standard) BLK - Black CC - Custom Color (provide RAL#)</p>	<p>8 - MOUNTING</p> <p>AC - Air Craft Cable (50") SM - Surface Mount WM - Wall Mount</p>	<p>9 - CONTROL</p> <p>EIS - Integral Sensor by Enlighted WIS - Integral Sensor by Wattstopper</p>	<p>10 - OPTICS</p> <p>SD - Standard Diffuser</p>	<p>11 - OPTIONS</p> <p>EM 120V - Emergency Pack EM 277V - Emergency Pack</p>	

www.speckaylighting.com | 646.837.9000 | quotes@kaylighting.com

December 2018

DISCLAIMER: KAY LIGHTING RESERVES THE RIGHT TO MAKE ANY DESIGN CHANGES FOR CONTINUOUS IMPROVEMENT WHICH WILL NOT AFFECT THE OVERALL APPEARANCE OR PERFORMANCE. ALL CEILINGS ARE TO BE ADEQUATELY REINFORCED BY OTHERS BEFORE INSTALLATION. ALL FIXTURES ARE TO BE WIRED BY A CERTIFIED ELECTRICIAN ONLY. THIS INFORMATION IS PROPERTY OF KAY LIGHTING, AND THE INFORMATION IT CONTAINS MAY NOT BE USED WITHOUT ANY WRITTEN CONSENT OF KAY LIGHTING.

DATE _____ PROJECT _____ FIRM _____ TYPE _____

MOUNTING OPTIONS

AC - Air Craft Cable (50")

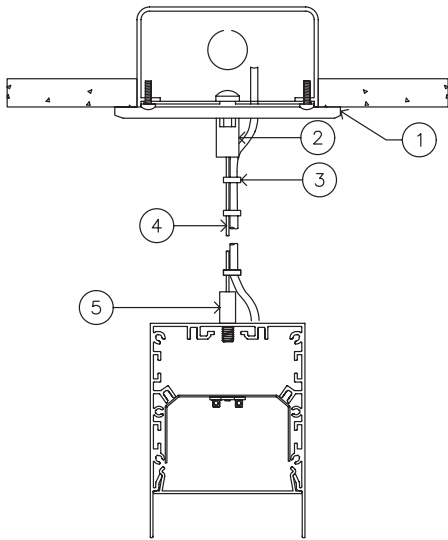

- 1 - 5" Round Canopy (Standard White Finish)
- 2 - Canopy Retainer
- 3 - S-JT Cord (Standard White)
- 4 - Air Craft Cable
- 5 - Gripper

SM - Surface Mount

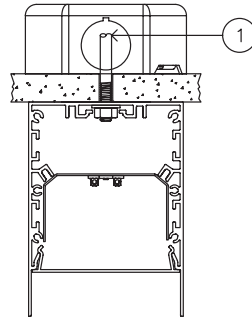

- 1 - Threaded Rod (not supplied)

WM - Wall Mount

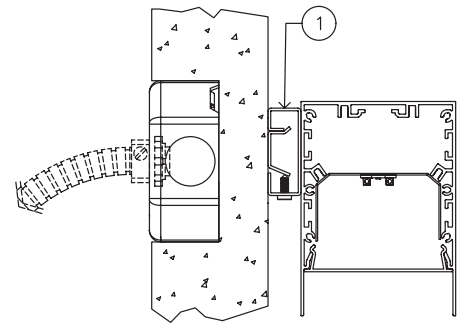

- 1 - 0.75" Wall Mount Bracket

CORNERS & PATTERNS

Available with illuminated corners, angles, and custom patterns. **Must consult factory for custom corners and patterns.**

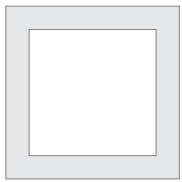

Square Patterns

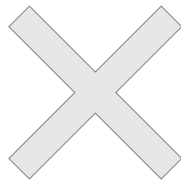

X Patterns

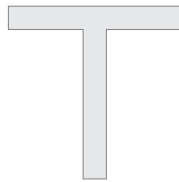

T Patterns

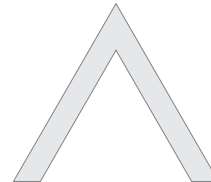

Custom Angles

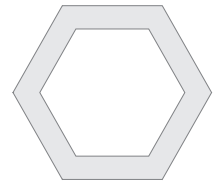

Custom Patterns

LENS CUT OPTIONS

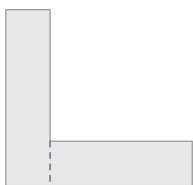

Straight-cut

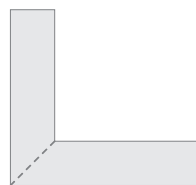

Mitered Angle

NOTE: Straight-Cut is standard configuration, Mitered Angle is optional and must be specified.

DATE

PROJECT

FIRM

TYPE

PHOTOMETRICS

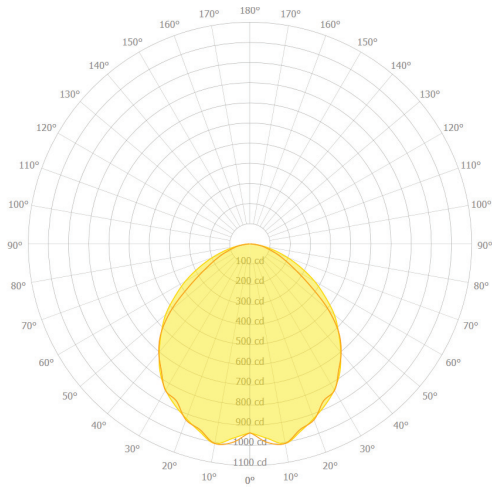

KLS2 LED RG 4FT LTG1 3500K
 DELIVERED LUMENS: 2,497Lm
 TOTAL WATTS: 29W
 EFFICACY: 86 Lumens/Watt

ZONAL LUMEN SUMMARY

ZONE	LUMENS	% LAMP	% FIXTURE
0.00 - 30.00	771.71	20.32	30.90
0.00 - 40.00	1246.03	32.80	49.90
0.00 - 60.00	2110.13	55.55	84.50
0.00 - 90.00	2497.30	65.74	100.00
90.00 - 120.00	0.56	0.01	0.02
90.00 - 150.00	0.56	0.01	0.02
90.00 - 180.00	0.56	0.01	0.02
0.00 - 180.00	2497.30	65.74	100.00

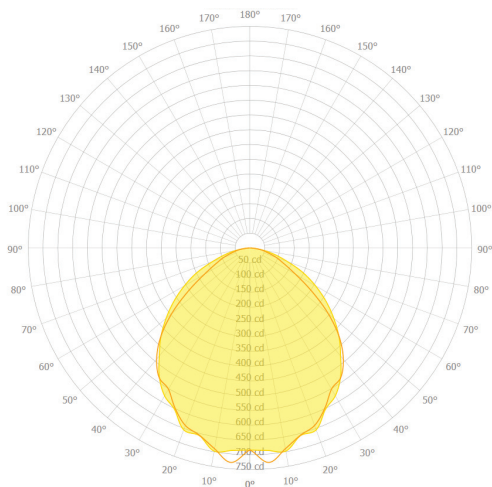

KLS2 LED RG 4FT LTG2 3500K
 DELIVERED LUMENS: 1,715Lm
 TOTAL WATTS: 20W
 EFFICACY: 86 Lumens/Watt

ZONAL LUMEN SUMMARY

ZONE	LUMENS	% LAMP	% FIXTURE
0.00 - 30.00	531.68	20.36	30.99
0.00 - 40.00	858.12	32.85	50.02
0.00 - 60.00	1449.93	55.51	84.51
0.00 - 90.00	1715.71	65.69	100.00
90.00 - 120.00	0.36	0.01	0.02
90.00 - 150.00	0.36	0.01	0.02
90.00 - 180.00	0.36	0.01	0.02
0.00 - 180.00	1715.71	65.69	100.00

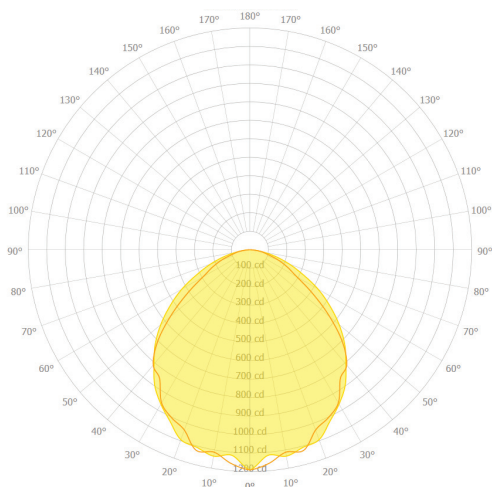

KLS2 LED RG 4FT LTG3 3500K
 DELIVERED LUMENS: 2,861Lm
 TOTAL WATTS: 35W
 EFFICACY: 81 Lumens/Watt

ZONAL LUMEN SUMMARY

ZONE	LUMENS	% LAMP	% FIXTURE
0.00 - 30.00	885.74	20.35	30.95
0.00 - 40.00	1430.00	32.85	49.97
0.00 - 60.00	2418.21	55.55	84.50
0.00 - 90.00	2861.74	65.74	100.00
90.00 - 120.00	0.64	0.01	0.02
90.00 - 150.00	0.64	0.01	0.02
90.00 - 180.00	0.64	0.01	0.02
0.00 - 180.00	2861.74	65.74	100.00